

STAS product catalogue



STAS
picture hanging systems



Index

Rail systems	4
Rail systems with lighting	16
Hooks and cords for rail systems	25
Magnetic hanging solutions	33
Other hanging solutions	35
Additional products	54
Product index	56



NEW

- STAS drywallXpress** **15**
Install a picture rail on drywall by just using your hands
- STAS qubic pro** **37**
One flexible to use hanging point, suitable for more difficult places.
- STAS v-tense & h-tense** **38**
Discover the many options of a tensioned cable system
- STAS name tag** **46**
A name card holder for the STAS papergrip
- STAS clocktica** **54**
A design clock suitable for most STAS picture rails

STAS on every wall

STAS picture hanging systems provides multifunctional hanging systems and hanging accessories for walls and ceilings.

We develop, manufacture and distribute safe and flexible hanging solutions for a wide range of wall objects. These can include both decorative objects (paintings, drawings) and practical items (whiteboards, coat hooks, mirrors). Many of our products are patented and have been awarded prizes.

Our goal is to offer people freedom as they use and decorate their walls. Sustainable building management and cost savings are key in our approach.

STAS was founded in 1995 by two brothers, Rien and André Stas, and today operates worldwide. The head office is located in Eindhoven, the Netherlands.

Rail systems

Index

Rail	Weight capacity	Installation	Adjoining to ceiling?	Page
STAS minirail	25 kg/m	wall	no	5
STAS cliprail	20 kg/m	wall	no	6
STAS cliprail max	25 kg/m	wall	yes	7
STAS cliprail pro	45 kg/m	wall	no	8
STAS plasterrail	20 kg/m	wall	n/a	9
STAS j-rail	25 kg/m	wall	no	10
STAS j-rail max	100 kg/m	wall	no	11
STAS u-rail	20 kg/m	ceiling	n/a	12
STAS windsor	20 kg/m	wall	no	13
STAS riva	20 kg/m	wall	yes	13
STAS evoluon	20 kg/m	wall	no	14
STAS drywallXpress	30 kg/m	wall	no	15

STAS minirail

sleek and strong



STAS minirail is characterised by its extremely slim, narrow design and innovative mounting method.

The rail itself is just 16 mm in height, yet it can carry up to 25 kg per linear metre. Thanks to an innovative screw, the STAS clipscrew, the rail can easily be fixed to the wall.

STAS minirail is perfect for creating an elegant, unobtrusive hanging system for light to medium-weight objects.

Features



Dimensions	9 x 16 mm
Length	150, 200 or 300 cm
Colour	white or alu (more colours on request)
Material	aluminium
Installation	wall mountable, not adjoining to ceiling
Weight capacity	25 kg/m ¹
Warranty	5 years



For matching hooks and cords, see page 26.

Parts

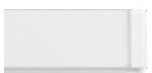

STAS minirail white
RM10150 150 cm
RM10120 200 cm
RM10130 300 cm



STAS minirail alu
RM30150 150 cm
RM30120 200 cm
RM30130 300 cm



STAS minirail rail connector
RD10200



STAS minirail combi cap white
RY10200
(2 x end cap / 1 x corner cap)



STAS minirail combi cap alu
RY30200
(2 x end cap / 1 x corner cap)



STAS minirail clipscrew torx
SR10200
(metal, 3 per m²)



STAS plug
SR50700

STAS cliprail

the perfect basis



STAS cliprail is a high-quality picture hanging system without bells and whistles. It is easy to install and feels right at home in every interior.

The cliprail owes its name to the specially designed fastening clip - the STAS railclip - which allows easy fixation to the wall.



Features



Dimensions	8.2 x 25 mm
Length	150, 200 or 300 cm
Colour	white or alu (more colours on request)
Material	aluminium
Installation	wall mountable, not adjoining to ceiling
Weight capacity	20 kg/m ¹
Warranty	5 years

For matching hooks and cords, see page 26.

Parts

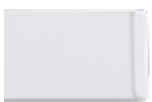

STAS cliprail white
RC10315 150 cm
RC10320 200 cm
RC10330 300 cm



STAS cliprail alu
RC30115 150 cm
RC30120 200 cm
RC30130 300 cm



STAS cliprail end cap white
RD10300



STAS cliprail end cap alu
RD30300



STAS cliprail corner cap white
RD10400



STAS cliprail corner cap alu
RD30400



STAS railclip
RD40100
(metal, 3 per m²)



STAS rail connector
RD40200
(metal)



STAS screw torx
SR30600



STAS plug
SR50700

STAS cliprail max

perfect gap-free ceiling connection



STAS cliprail max is a hanging system for the perfectionist. An extra rim ensures the rail connects beautifully with the ceiling. With this system, your ceiling, wall and picture hanging system unite as one.

The rail is most attractive when fixed to flat ceilings. STAS cliprail max owes its name to the specially designed fastening clip - the STAS railclip - which allows easy fixation to the wall.

For the best result, you can neatly finish the transition between the STAS cliprail max and the ceiling by adding an (acrylic) sealant.

Features



Dimensions	8.3 x 31.6 mm
Length	150, 200 or 300 cm
Colour	white or alu (more colours on request)
Material	aluminium
Installation	wall mountable, adjoining to ceiling
Weight capacity	25 kg/m ¹
Warranty	5 years



For matching hooks and cords, see page 26.

Parts



STAS cliprail max white
RC10215 150 cm
RC10220 200 cm
RC10230 300 cm



STAS cliprail max alu
RC30215 150 cm
RC30220 200 cm
RC30230 300 cm



STAS cliprail max combi cap white
RY10100
(2 x end cap / 1 x corner cap)



STAS cliprail max combi cap alu
RY30100
(2 x end cap / 1 x corner cap)



STAS railclip
RD40100
(metal, 3 per m²)



STAS rail connector
RD40200
(metal)



STAS screw torx
SR30600



STAS plug
SR50700

STAS cliprail pro

elegant powerhouse



STAS cliprail pro is ideal for hanging heavier objects on walls thanks to its thick-walled profile. This rail can carry an amazing 45 kg per linear metre.

Despite its large weight-bearing capacity, the STAS cliprail pro is an elegant, unobtrusive rail that can be used in professional environments as well as in the home.

STAS cliprail pro owes its name to the specially designed fastening clip - the STAS railclip - which allows easy fixation to the wall.



Features



Dimensions	11.3 x 28 mm
Length	150, 200 or 300 cm
Colour	white or alu (more colours on request)
Material	aluminium
Installation	wall mountable, not adjoining to ceiling
Weight capacity	45 kg/m ¹
Warranty	5 years

For matching hooks and cords, see page 26.

Parts



STAS cliprail pro white
VC10150 150 cm
VC10200 200 cm
VC10300 300 cm



STAS cliprail pro alu
VC30150 150 cm
VC30200 200 cm
VC30300 300 cm



STAS cliprail pro end cap white
VE10200



STAS cliprail pro end cap alu
VE30200



STAS cliprail pro corner cap white
VD10400



STAS cliprail pro corner cap alu
VD30400



STAS railclip
RD40100
(metal, 3 per m²)



STAS rail connector
RD40200
(metal)



STAS screw
SR30100



STAS plug
SR50700

STAS plasterrail for the forward thinker



Practically invisible, but by no means less functional. STAS plasterrail is the only picture hanging system in our range which can be fully integrated into a new stucco wall. So it's ideal for new-build projects and renovations.

The steel rail is fixed to the bare wall. After plastering, only a small opening of approximately 4 mm is visible in the stucco. Cords specially designed for the plasterrail can then be hooked in through this opening.

To prevent from any plaster entering the rail during plaster work, a cord must be placed in the rail opening before the work begins.

Features

Dimensions	10.5 x 45 mm
Length	12 mm
Colour	250 cm
Material	galvanised steel
Installation	wall mountable, integrated in stucco
Weight capacity	20 kg/m ¹
Warranty	5 years

For matching hooks and cords, see page 29.



Parts



STAS plasterrail
RS30250 250 cm



**STAS plasterrail
connector**
RS30251



**STAS plasterrail
plaster cord**
RS30260

STAS j-rail

professional versatility



The design of STAS j-rail was based on the shape of the letter J. This shape allows the rail to be combined in all kinds of different ways using hooks, cords and even rods.

For example, by using a rod instead of a cord or steel cable, moving or alternating works of art on high ceilings becomes a piece of cake. You won't need a ladder, because the rod can be lifted out of the rail from below.

STAS j-rail has a somewhat industrial look and is applied regularly in art galleries and in business premises.



Features

Dimensions	7 x 20 mm
Length	150, 200 or 300 cm
Colour	white or alu (more colours on request)
Material	aluminium
Installation	wall mountable, not adjoining to ceiling
Weight capacity	25 kg/m ¹
Warranty	5 years

For matching hooks, cords and rods see page 27.

Parts



STAS j-rail white
 RJ10115 150 cm
 RJ10120 200 cm
 RJ10130 300 cm
 (4 holes per m²)



STAS j-rail alu
 RJ30115 150 cm
 RJ30120 200 cm
 RJ30130 300 cm
 (4 holes per m²)



**STAS j-rail screw
 flush head white**
 SJ10100



**STAS j-rail screw
 flush head alu**
 SJ30100



STAS plug
 SR50700

STAS j-rail max heavyweight champion



STAS j-rail max is designed for the heavy objects. The thick-walled aluminium profile is capable of supporting loads of up to 100 kg per linear metre.

What's more, STAS j-rail max is combined with rods instead of cords, which makes alternating and moving heavy works of art on high ceilings a piece of cake. You won't need a ladder, because the rod can be lifted out of the rail from below.

The STAS j-rail max system is also available with theft-delaying security hooks and is often used in art galleries and museums.



Features

Dimensions	9 x 20 mm
Length	150, 200 or 300 cm
Colour	white or alu (more colours on request)
Material	aluminium
Installation	wall mountable, not adjoining to ceiling
Weight capacity	100 kg/m ¹
Warranty	5 years

For matching hooks and rods, see page 28.



Parts

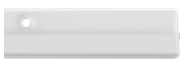

STAS j-rail max white
RJ10215 150 cm
RJ10220 200 cm
RJ10230 300 cm
(4 holes per m²)



STAS j-rail max alu
RJ30215 150 cm
RJ30220 200 cm
RJ30230 300 cm
(4 holes per m²)



**STAS j-rail max screw
sunk head white**
SJ10200



**STAS j-rail max screw
sunk head alu**
SJ30200



STAS plug
SR50700

STAS u-rail

suspended ceiling becomes hanging system



STAS u-rail is specially designed for suspended ceilings. The rail is easily and almost invisibly attached to the supporting edge trim of the suspended ceiling.

STAS u-rail is also ideally suited for hanging whiteboards, art or large maps. So now, with just a small modification, your suspended ceiling becomes a versatile picture hanging system, ideal for use in offices, schools and healthcare facilities.



Features



Dimensions	14 x 6.5 mm
Length	150, 200 or 300 cm
Colour	white, black or alu (to match the edge trim)
Material	aluminium
Installation	ceiling mountable
Weight capacity	20 kg/m ¹
Warranty	5 years

For matching hooks and cords, see page 26.

Parts



STAS u-rail white
 RP10115 150 cm
 RP10120 200 cm
 RP10130 300 cm
 (8 holes per m²)



STAS u-rail alu
 RP30115 150 cm
 RP30120 200 cm
 RP30130 300 cm
 (8 holes per m²)



STAS u-rail black
 RP20115 150 cm
 RP20120 200 cm
 RP20130 300 cm
 (8 holes per m²)



STAS u-rail screw white
 SP10100



STAS u-rail screw alu
 SP30100



STAS u-rail screw black
 SP20100

STAS windsor & riva

bring a piece of nature into your home



In addition to aluminum rails, STAS also offers wooden rails in 2 different models. The STAS windsor is elegant and warm where the STAS riva has a more robust look and feel. Two distinctive models, suitable for any interior! Both models are easy to use and each has a different profile for which fitting hooks are available.

Our wooden rails are made out of Ayous wood and are FSC and PEFC certificated. Ayous wood differs from other wood since it does not deform or splinter, and is perfectly suitable to repaint because of its smooth texture. Perfect wood for your picture hanging system! Can be mounted screwed, nailed and glued*.

* The weight capacity of a glued rails is highly dependent on the surface, so care must be taken here. More information on how to best glue our wooden rails can be found on our website www.stasgroup.com

Features STAS windsor

Dimensions	18 x 45 mm
Length	± 120, 240 cm
Material	Ayous wood
Installation	wall mountable, not adjoining to ceiling
Weight capacity	20 kg/m
Warranty	5 years

For matching hooks and cords, see page 30.



Features STAS riva

Dimensions	17 x 45 mm
Length	± 120, 240 cm
Material	Ayous wood
Installation	wall mountable, adjoining to ceiling
Weight capacity	20 kg/m
Warranty	5 years



STAS windsor
RP50220 120 cm
RP50224 240 cm



STAS riva
RP50120 120 cm
RP50124 240 cm

STAS evoluon

bends along with you



From now on, curved walls can also be used optimally with the STAS evoluon! The STAS evoluon has been specially developed for curved walls, but this rail is just as easy to mount on straight walls or (slightly) undulating walls.

The rail is bendable and can be bent perfectly proportional along the contours of a wall by means of a supplied auxiliary tool. In this way, the STAS evoluon provides hanging possibilities for difficult and walls otherwise unusable for picture rails.



Features

Dimensions	26 x 3 mm
Length	200 cm
Colour	alu
Material	aluminium
Installation	wall mountable, not adjoining to ceiling
Weight capacity	20 kg/m
Warranty	5 years

For matching hooks and cords, see page 31.

Parts



STAS evoluon
TCS30020 200 cm
(4 holes per m1)



STAS bending mold evoluon
TCS9020 30 cm



STAS distance holder evoluon
TCS9012



STAS screw evoluon
SJ30300



STAS plug
SR50700



STAS evoluon hook
TCS9016

NEW

STAS drywallXpress

no stress with the STAS drywallXpress

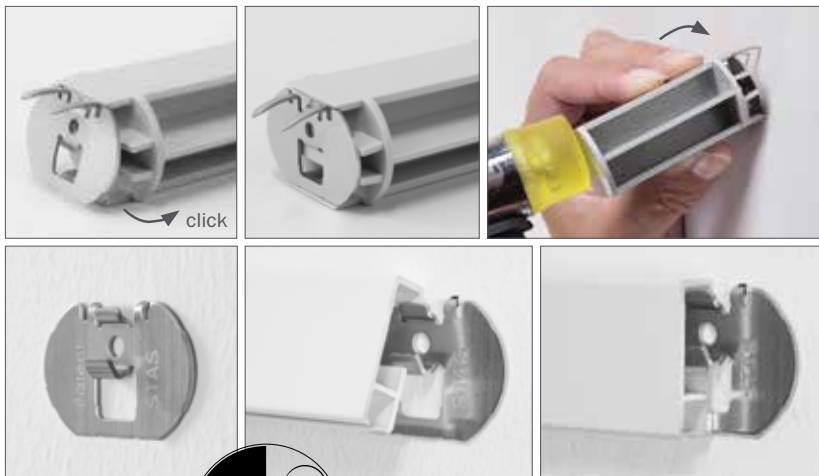

With the STAS drywallXpress you can mount a picture hanging system on a plaster wall in no time. No need to pick up that drill because you don't have to drill to assemble this system. The STAS drywallXpress is a complete picture hanging system that consists of clips, rail and an auxiliary tool. With the help of the enclosed tool and a hit with a hammer you can easily push the metal clips into your plaster wall. Click the rail onto the clips and combine this picture hanging system with the STAS cords with cobra.

STAS drywallXpress: the easiest picture hanging system in the world!

Features

Dimensions	rail: 8.2 x 25 mm clip: 23 x 35 x 18 mm
Colour	rail: white, alu clip: RVS
Material	rail: aluminium clip: RVS
Installation	wall mounting, not adjoining to ceiling
Weight capacity	20 kg/m
Warranty	5 years

For matching hooks and cords, see page 26.



Parts

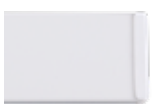

STAS cliprail white
RC10315 150 cm
RC10320 200 cm
RC10330 300 cm



STAS cliprail alu
RC30115 150 cm
RC30120 200 cm
RC30130 300 cm



STAS cliprail end cap white
RD10300



STAS cliprail end cap alu
RD30300



STAS cliprail corner cap white
RD10400



STAS cliprail corner cap alu
RD30400



STAS drywall clip
RD40400



STAS drywall tool
RD40501



STAS drywallXpress connector
RT40200



Rail systems with lighting

Index

Rail	Weight capacity	Installation	Adjoining to ceiling?	Page
STAS multirail	45 kg/m ¹	wall	no	17
STAS multirail max	45 kg/m ¹	wall	yes	18
STAS multirail crown	45 kg/m ¹	wall	n/a	19
STAS multirail flat	45 kg/m ¹	ceiling	n/a	20
STAS u-rail multi	30 kg/m ¹	ceiling	n/a	21
STAS fixtures	n/a	n/a	n/a	22
STAS spotlights	n/a	n/a	n/a	23
STAS adapters	n/a	n/a	n/a	24

STAS multirail

hanging and lighting rolled into one



A STAS multirail system is a picture hanging system and artwork lighting rolled into one.

Inside the rail, 12 V wiring (low voltage) has been integrated. Various matching light fixtures can then be clicked into the rail at any position you choose, accentuating your wall decorations. In combination with LED lighting, the STAS multirail is very energy efficient.

Features



Dimensions	11.3 x 28 mm
Length	150, 200 or 300 cm
Colour	white or alu (more colours on request)
Material	aluminium
Installation	wall mountable, not adjoining to ceiling
Weight capacity	45 kg/m ¹
Voltage	12 V (low voltage)
Adapter	18 W, 60 W, 96 W
Warranty	5 years on rails, 1 year on accessories

For matching hooks and cords, see page 26.
For matching accessories, see page 22 to 24.



Parts



STAS multirail white
VH10150 150 cm
VH10200 200 cm
VH10300 300 cm



STAS multirail alu
VH30150 150 cm
VH30200 200 cm
VH30300 300 cm



STAS multirail end cap white
VE10200



STAS multirail end cap alu
VE30200



STAS multirail corner cap white
VD10400



STAS multirail corner cap alu
VD30400



STAS railclip
RD40100
(metal, 3 per m²)



STAS rail connector
RD40200
(metal)



STAS screw torx
SR30600



STAS plug
SR50700



STAS multirail conductor 12 V straight
VF50200



STAS multirail conductor 12 V corner
VF50100

STAS multirail max

perfect gap-free ceiling connection



A STAS multirail system is a picture hanging system and artwork lighting rolled into one. Inside the rail, 12 V wiring (low voltage) has been integrated. Various matching light fixtures can then be clicked into the rail at any position you choose, to accentuate your wall decorations.

The STAS multirail max distinguishes itself thanks to the extra rim that ensures a tight fit against flat ceiling surfaces. With this system, your ceiling, wall and picture hanging system unite as one. Cables can be hidden behind the rim.

For the best result, you can neatly finish the transition between the STAS multirail max and the ceiling by applying an (acrylic) sealant.



Features



Dimensions	11.3 x 38.3 mm
Length	200 or 300 cm
Colour	white or alu (more colours on request)
Material	aluminium
Installation	wall mountable, adjoining to ceiling
Weight capacity	45 kg/m ¹
Voltage	12 V (low voltage)
Adapter	18 W, 60 W, 96 W
Warranty	5 years on rails, 1 year on accessories

For matching hooks and cords, see page 26.
For matching accessories, see page 22 to 24.

Parts



STAS multirail max white
VC10420 200 cm
VC10430 300 cm



STAS multirail max alu
VC30420 200 cm
VC30430 300 cm



STAS prorail max white
RM10415 150 cm
RM10420 200 cm
RM10430 300 cm
rail without 12 V power supply insert



STAS multirail max end cap white
VE10400



STAS multirail max end cap alu
VE30400



STAS multirail max corner cap white
VD20500



STAS multirail max corner cap alu
VD30500



STAS railclip
RD40100
(metal, 3 per m²)



STAS rail connector
RD40200
(metal)



STAS screw torx
SR30100



STAS plug
SR50700



STAS multirail conductor 12 V straight
VF50200



STAS multirail conductor 12 V corner
VF50100

STAS multirail crown moulding in the spotlights



A STAS multirail system is a picture hanging system and artwork lighting rolled into one.

Inside the rail, 12 V wiring (low voltage) has been integrated. Various matching light fixtures can then be clicked into the rail at any position you choose, to accentuate your wall decorations.

STAS multirail crown is a picture hanging system that is mounted virtually invisibly on the wall and can be combined with a moulding of your choice.

Features

Dimensions	12.7 x 37.5 mm
Length	200 or 300 cm
Colour	white (more colours on request)
Material	aluminium
Installation	wall mountable
Weight capacity	45 kg/m ¹
Voltage	12 V (low voltage)
Adapter	18 W, 60 W, 96 W
Warranty	5 years on rails, 1 year on accessories

For matching hooks and cords, see page 26.
For matching accessories, see page 22 to 26.



Parts

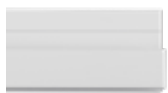

STAS multirail crown white
RC10420 200 cm
RC10430 300 cm



STAS multirail crown rail connector
RD20400



STAS multirail crown corner connector
RD20500



STAS multirail crown screw
SJ10200

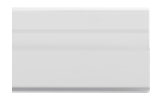

STAS prorail crown white
RH10415 150 cm
RH10420 200 cm
RH10430 300 cm
rail without 12 V power supply insert



STAS plug
SR50700



STAS multirail conductor 12 V straight
VF50200



STAS multirail conductor 12 V corner
VF50100

STAS multirail flat concealed class



A STAS multirail system is a picture hanging system and artwork lighting rolled into one.

Inside the rail, 12 V wiring (low voltage) has been integrated. Various matching light fixtures can then be clicked into the rail at any position you choose, to accentuate your wall decorations.

STAS multirail flat is a ceiling-mounted picture hanging system that can be virtually invisibly integrated with stucco work or with a single or double flat moulding. It is even possible to glue the rail to a plaster, timber or foam moulding or to a timber ceiling.



Features



Dimensions	31.3 x 18 mm
Length	200 or 300 cm
Colour	white (more colours on request)
Material	aluminium
Installation	ceiling mountable
Weight capacity	45 kg/m ¹
Voltage	12 V (low voltage)
Adapter	18 W, 60 W, 96 W
Warranty	5 years on rails, 1 year on accessories

For matching hooks and cords, see page 26.
For matching accessories, see page 22 to 24.

Parts

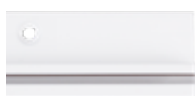

STAS multirail flat white
RC10520 200 cm
RC10530 300 cm
(4 holes per m²)



STAS multirail flat rail connector
RD20400



STAS multirail flat corner connector
RD20500



STAS multirail flat screw
SJ10200

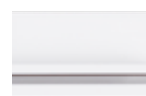

STAS prorail flat white
RH10515 150 cm
RH10520 200 cm
RH10530 300 cm
rail without 12 V power supply insert (4 holes per m²)



STAS plug
SR50700



STAS multirail conductor 12 V straight
VF50200



STAS multirail conductor 12 V corner
VF50100

STAS u-rail multi lighting rail for suspended ceilings



A STAS multirail system is a picture hanging system and artwork lighting rolled into one.

Inside the rail, 12 V wiring (low voltage) has been integrated. Various matching light fixtures can then be clicked into the rail at any position you choose, to accentuate your wall decorations.

STAS u-rail multi is purpose-designed for suspended ceilings. The rail is easily and almost invisibly attached to the supporting edge trim of the suspended ceiling. STAS u-rail multi also offers a perfect solution for hanging whiteboards, art or large maps.

Features

Dimensions	17.3 x 13.4 mm
Length	200 or 300 cm
Colour	white, black or alu (to match the edge trim)
Material	aluminium
Installation	ceiling mountable
Weight capacity	30 kg/m ¹
Voltage	12 V (low voltage)
Adapter	18 W, 60 W, 96 W
Warranty	5 years on rails, 1 year on accessories

For matching hooks and cords, see page 26.
For matching accessories, see page 22 to 24.



Parts



STAS u-rail multi white
VP10200 200 cm
VP10300 300 cm
(8 holes per m²)



STAS u-rail multi alu
VP30200 200 cm
VP30300 300 cm
(8 holes per m²)



STAS u-rail multi black
VP20200 200 cm
VP20300 300 cm
(8 holes per m²)



STAS u-rail screw white
SP10100



STAS u-rail screw alu
SP30100



STAS u-rail screw black
SP20100



STAS multirail conductor 12 V straight
VF50200



STAS multirail conductor 12 V corner
VF50100

STAS multirail accessories fixtures

STAS offers a choice of 4 different light fixtures in various lengths. Your choice depends on your personal preference and on the size of the artwork you wish to illuminate. Every light fixture fits on all multirail systems.

Tips

- The bigger the distance between light source and wall, the bigger the artwork that can be illuminated. In other words: choose a large fixture for lighting a large work of art.
- Is your wall 270 cm high or higher? We would recommend installing a fixture of 70 cm.

Adjusting

All fixtures have a flexible or hinged part with which small adjustments to the beam angle can be made.

1 year warranty applies to all multirail accessories.



STAS multirail fixture classic white
VA10500 50 cm
VA10700 70 cm



STAS multirail fixture classic chrome
VA30500 50 cm
VA30700 70 cm



STAS multirail fixture sirius chrome
VA30365 40 cm
VA30465 50 cm
VA30665 65 cm



STAS multirail fixture signo chrome
VA30770 70 cm

STAS multirail accessories spotlights

STAS offers 3 different LED spotlights. Your choice depends on your personal preference in terms of energy efficiency, light colour, warmth radiation and the shape and intensity of the light beam. All spotlights fit on all light fixtures. 1 year warranty applies to all multirail accessories.



STAS LED spot 3.5 W / 27°



Emits a narrow beam of light suitable for small paintings.

	VL10200
Power	3.5 W
Output equivalent	20 W
Max. consumption	3.5 W
Light intensity	200 lm
Infrared radiation	none
Light colour	warm white
Colour temperature	2700 K
Light beam	standard - diffuse
Beam angle	27°
Socket	MR11-GU4.0
Vibrational impact	low
Lifespan	40.000
Energy class	A+

STAS LED spot 3.5 W / 95°

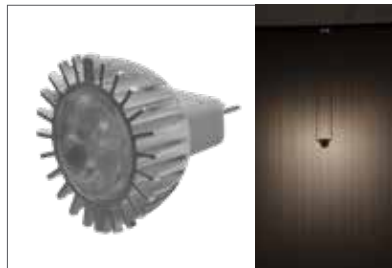

Emits a wide beam of light suitable for large artworks.

	VL10900
Power	3.5 W
Output equivalent	20 W
Max. consumption	3.5 W
Light intensity	200 lm
Infrared radiation	none
Light colour	warm white
Colour temperature	2700 K
Light beam	standard - diffuse
Beam angle	95°
Socket	MR11-GU4.0
Vibrational impact	low
Lifespan	40.000
Energy class	A+

STAS powerLED 4 W matt



The closed housing avoids light spill at the back.

	VL10700
Power	< 4 W
Output equivalent	20 W
Max. consumption	3.4 W
Light intensity	170 lm
Infrared radiation	none
Light colour	neutral white
Colour temperature	3000 K
Light beam	standard - diffuse
Beam angle	30°
Socket	MR11-GU4.0
Vibrational impact	low
Lifespan	20.000
Energy class	A+

STAS multirail accessories

adapters

The choice of an adapter depends on 3 things:

1. the type of spotlight you'd like to use
2. the number of spotlights you'd like to install
3. the number of metres of rail you'd like to install

View the tables below for the best choice.

Using multiple adapters

In case you would like to use more than the below mentioned number of metres or spots, you will have to use multiple adapters.

CAUTION:

Create independent circuits when using more than one adapter! Adapters must never be connected, neither directly nor indirectly. In short: NEVER connect two rail segments that are each connected to a different adapter! Exclusively connect rail segments that share one adapter.

Dimming of light

The current STAS adapters are not yet dimmable. We strongly advise against connecting your own switch or dimmer to the system. Be aware that if you do this anyway, all system warranty expires.



STAS multirail adapter 18 W
VT20500



STAS multirail adapter 60 W
VT20400



STAS multirail adapter 96 W
VT20300

STAS adapters			
	VT20500 STAS multirail adapter 18 W	VT20400 STAS multirail adapter 60 W	VT20300 STAS multirail adapter 96 W
Input voltage	AC100-240 V ~ 50/60 Hz 0.7 A	AC100-240 V ~ 50/60 Hz 1.6 A	AC100-240 V ~ 50/60 Hz 2 A
Output voltage	DC 12 V == 1.5 A	DC 12 V == 5 A	DC 12 V == 8 A
Ampère	1.5 A	5 A	8 A
Dimensions (l x h x b)	75 x 86 x 36 mm	110 x 32 x 62 mm	149 x 38 x 65 mm
Weight	180 gram	415 gram	600 gram
Connection	input plug (EU) output cable 3 m	input cable (EU) 1.2 m output cable 3 m	input cable (EU) 1.5 m output cable 3 m
Quality label	CE GS TÜV WEEE ROHS	UL CE GS TÜV WEEE ROHS	UL CE GS TÜV WEEE

Number of spotlights

		LED 3.5 W	LED 4 W
VT20500	Adapter 18 W	4	3
VT20400	Adapter 60 W	15	12
VT20300	Adapter 96 W	25	20
	Maximum number of metres of rail per adapter	16	16

Hooks and cords for rail systems

Index

STAS hooks and cords	26
STAS j-rail hooks, cords and rods	27
STAS j-rail max hooks and rods	28
STAS plasterrail hooks and cords	29
STAS windsor & riva hooks and cords	30
STAS evoluon & qubic hooks and cords	31
Summary table hooks and cords	32

STAS hooks and cords



After selecting a rail, choose a cord to hook anywhere into the rail and a hook to slide over the cord to the desired height.



The cords and hooks on this page can be combined with all STAS rail types, with the exception of the STAS wooden rails, STAS j-rail (max), STAS evoluon and STAS plaster rail.

Cords



STAS cobra with perlon cord
 CP10110 100 cm
 CP10115 150 cm
 CP10120 200 cm
 CP10125 250 cm
 CP10130 300 cm
 CP10140 400 cm



STAS cobra with steel cable
 SC10110 100 cm
 SC10115 150 cm
 SC10120 200 cm
 SC10125 250 cm
 SC10130 300 cm
 SC10140 400 cm



STAS cobra with steel cable white
 SC10220 200 cm

STAS cobra with steel cable black
 SC20220 200 cm

Hooks



STAS smartspring
 HA30900



STAS zipper
 HA30501



STAS zipper pro
 HA30530

Possible combinations



max.
4 kg

perlon cord + smartspring



max.
15 kg

perlon cord + zipper or zipper pro



max.
20 kg

steel cable + zipper or zipper pro



max.
10 kg

steel cable white or black + zipper or zipper pro

STAS j-rail hooks, cords and rods

STAS j-rail has its own set of hooks, cords and rods with which to complete the system.



Cords, rods and rail hooks



STAS perlon cord with loop
 PL10110 100 cm
 PL10115 150 cm
 PL10120 200 cm
 PL10125 250 cm
 PL10130 300 cm



STAS steel cable with loop
 SL10110 100 cm
 SL10115 150 cm
 SL10120 200 cm
 SL10125 250 cm
 SL10130 300 cm



STAS j-rail s-hook white
 HR10400

STAS j-rail s-hook chrome
 HR30400



STAS cylinder hook white
 HR10600

STAS cylinder hook alu
 HR30600

STAS perlon cord with disk
 PH10110 100 cm
 PH10115 150 cm
 PH10120 200 cm
 PH10125 250 cm
 PH10130 300 cm



STAS j-rail rod 3 mm white
 SO10110 100 cm
 SO10115 150 cm
 SO10120 200 cm
 SO10130 300 cm



STAS j-rail rod 3 mm alu
 SO30110 100 cm
 SO30115 150 cm
 SO30120 200 cm
 SO30130 300 cm

Hooks



STAS smartspring
 HA30900



STAS zipper
 HA30501



STAS zipper pro
 HA30530



STAS j-rail spring hook
 HA30700

Possible combinations



max.
4 kg

j-rail s-hook + perlon cord with loop + smartspring, zipper or zipper pro



max.
20 kg

j-rail s-hook + steel cable with loop + zipper or zipper pro



max.
4 kg

cylinder hook + perlon cord with disk + smartspring



max.
15 kg

cylinder hook + perlon cord with disk + zipper or zipper pro



max.
15 kg

j-rail rod + spring hook

STAS j-rail max hooks and rods

STAS j-rail max works only with rods and matching hooks.



Rods



STAS j-rail max rod 4x4 white
 SM10110 100 cm
 SM10115 150 cm
 SM10120 200 cm
 SM10125 250 cm



STAS j-rail max rod 4x4 alu
 SM30110 100 cm
 SM30115 150 cm
 SM30120 200 cm
 SM30125 250 cm



STAS j-rail max rod 4x10 white
 SM10210 100 cm
 SM10215 150 cm
 SM10220 200 cm
 SM10225 250 cm



Hooks



STAS j-rail max hook for rod 4x4
 HA40600



STAS j-rail max security hook 4x4
 HA40700



STAS j-rail max security set, collar + cap
 BK10200



STAS j-rail max hook for rod 4x10
 HA40500

Possible combinations



j-rail max rod 4x4 + j-rail max (security) hook



j-rail max rod 4x4 + j-rail max (security) hook + security set



j-rail max rod 4x10 + j-rail max hook for rod 4x10

max.
40 kg

max.
40 kg

max.
100 kg

STAS plasterrail hooks and cords

STAS plasterrail has its own cords that are specially designed for the specific rail opening.



Cords and rail hooks



STAS perlon cord with loop
 PL10110 100 cm
 PL10115 150 cm
 PL10120 200 cm
 PL10125 250 cm
 PL10130 300 cm



STAS steel cable with loop
 SL10110 100 cm
 SL10115 150 cm
 SL10120 200 cm
 SL10125 250 cm
 SL10130 300 cm



STAS plasterrail S-hook chrome
 RS30270
 (for cord with loop)



STAS perlon cord with plasterrail hook
 PA10150 150 cm



Hooks



STAS smartspring
 HA30900



STAS zipper
 HA30501



STAS zipper pro
 HA30530

Possible combinations



max.
4 kg

plasterrail s-hook + perlon cord with loop + smartspring, zipper or zipper pro



max.
20 kg

plasterrail s-hook + steel cable with loop + zipper or zipper pro



max.
4 kg

perlon cord with plasterrail hook + zipper or zipper pro

STAS windsor & riva hooks and cords

STAS windsor & riva have their own collection of hooks, which can be combined with the existing hooks and cords from STAS.



Cords and rail hooks



STAS perlon cord with loop
 PL10110 100 cm
 PL10115 150 cm
 PL10120 200 cm
 PL10125 250 cm
 PL10130 300 cm



STAS steel cable with loop
 SL10110 100 cm
 SL10115 150 cm
 SL10120 200 cm
 SL10125 250 cm
 SL10130 300 cm



STAS hook windsor
 HW10200 white



STAS hook windsor
 HW30200 alu



STAS hook windsor
 HW60200 gold



STAS hook riva
 HW50700

Hooks



STAS smartspring
 HA30900



STAS zipper
 HA30501



STAS zipper pro
 HA30530

Possible combinations



max.
4 kg

perlon cord with loop + smartspring



max.
15 kg

perlon cord with loop + zipper or zipper pro



max.
20 kg

steelcable with loop + zipper or zipper pro

STAS evoluon & qubic (pro) hooks and cords

The STAS evoluon and the STAS qubic (pro) can be used with our special hooks and cords.



Cords



STAS perlon cord with glider

PH10013	13 cm
PH10110	100 cm
PH10115	150 cm
PH10120	200 cm
PH10125	250 cm
PH10130	300 cm



STAS steelcable with glider

SH10313	13 cm
SH10110	100 cm
SH10115	150 cm
SH10120	200 cm
SH10125	250 cm
SH10130	300 cm
SH10145	450 cm

Hooks



STAS smartspring
HA30900



STAS zipper
HA30501



STAS zipper pro
HA30530

Possible combinations

STAS evoluon

For more information about the STAS evoluon, see page 14.



max.
4 kg

STAS evoluon
hook + perlon
cord with glider
+ smartspring



max.
15 kg

STAS evoluon
hook + perlon
cord with glider
+ zipper



max.
15 kg

STAS evoluon
hook + steel
cable with glider
+ zipper



max.
4 kg

STAS qubic +
perlon cord
with glider
+ smartspring



max.
15 kg

STAS qubic +
perlon cord
with glider
+ zipper



max.
20 kg

STAS qubic
+ steel cable
with glider
+ zipper

Summary table hooks and cords

Hooks	smartspring	zipper / zipper pro	spring hook	j-rail max hook for rod 4x4	j-rail max security hook 4x4	j-rail max hook for rod 4x10
Cords						
all STAS rails (excl. STAS j-rail, STAS j-rail max, STAS plasterrail, STAS windsor, STAS riva and STAS evoluon)						
perlon cord with cobra	4 kg	15 kg	-	-	-	-
steel cable with cobra	-	20 kg	-	-	-	-
steel cable black or white with cobra	-	10 kg	-	-	-	-
STAS j-rail						
cylinderhook and perlon cord with disk	4 kg	15 kg	-	-	-	-
s-hook and perlon cord with loop	4 kg	15 kg	-	-	-	-
s-hook and steel cable with loop	-	20 kg	-	-	-	-
rod	-	-	15 kg	-	-	-
STAS j-rail max						
rod 4x4 white or alu	-	-	-	40 kg	40 kg	-
rod 4x10 white	-	-	-	-	-	100 kg
STAS plasterrail						
perlon cord with plasterrail hook	4 kg	15 kg	-	-	-	-
s-hook and perlon cord with loop	4 kg	15 kg	-	-	-	-
s-hook and steel cable with loop	-	20 kg	-	-	-	-
STAS windsor & riva						
hook with perlon cord with loop	4 kg	15 kg	-	-	-	-
hook with steel cable with loop	-	20 kg	-	-	-	-
STAS evoluon & qubic (pro)						
perlon cord with glider	4 kg	15 kg	-	-	-	-
steel cable with glider	-	20 kg	-	-	-	-
Additional (e.g. panel hooks)						
perlon cord with loop	4 kg	15 kg	-	-	-	-
steel cable with loop	-	20 kg	-	-	-	-



Magnetic hanging solutions

Index

STAS magnet sets

34

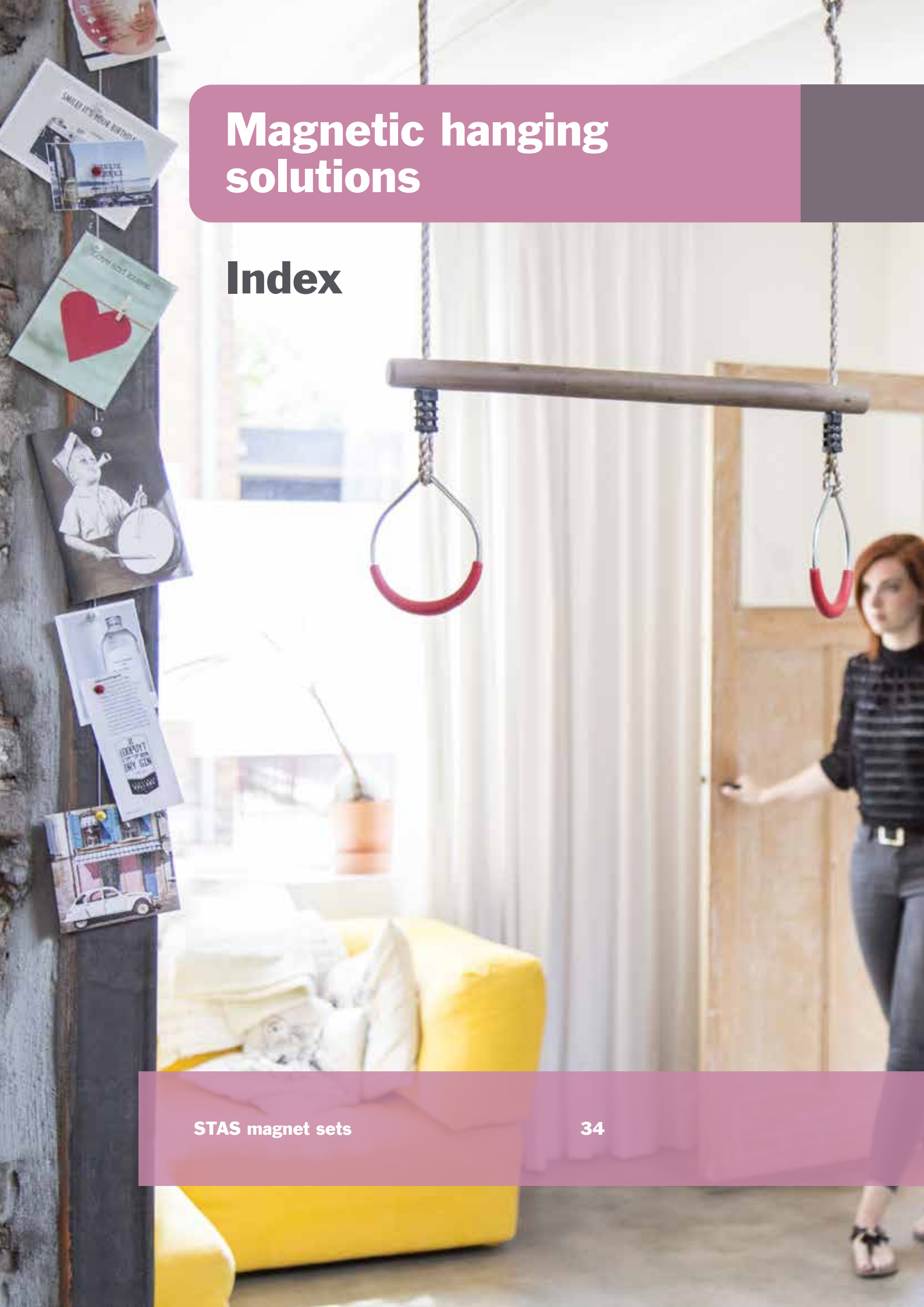

STAS magnet sets

cards on a cable



A STAS magnet set consists of a steel cable with cobra and five or ten magnets. Hook the steel cable into your STAS rail. Using the magnets, you can then hang photos, cards and memos on the cable. It's ideal for Christmas cards, birthday cards, to-do notes or temporary displays.

STAS offers a choice of three magnet sets: white, coloured or 2-in-1.

The white and coloured variants of the STAS magnet set cannot be combined with STAS wooden rails, STAS j-rail (max), STAS evoluon and STAS plaster rail. The 2-in-1 variant can be combined with all STAS rails except for STAS j-rail max, and STAS evoluon.



STAS magnet set

The standard STAS magnet set consists of a steel cable with cobra and ten white tripod magnets.

STAS coloured magnet set

The STAS coloured magnet set consists of a steel cable and ten cone-shaped magnets in five different colours.

STAS magnet set 2-in-1

The STAS magnet set 2-in-1 can be used in two different ways. Hook the cable into your STAS rail with the cobra or hang it with a loop onto an edge panel hook or any other hook. This set comes with five cone-shaped magnets in five different colours.



Products



STAS magnet set
BM20360
steel cable 150 cm
with cobra, 10 white
neodymium magnets



STAS white magnets
MB10050
10 separate, white
neodymium magnets



STAS coloured magnet set
BM20370
steel cable, 150 cm
with cobra, 10 coloured
neodymium magnets



STAS coloured magnets
MB10040
10 separate, coloured
neodymium magnets



STAS magnet set 2-in-1
BM20380
steel cable, 150 cm
with cobra and loop, 5
coloured neodymium
magnets

Other hanging solutions

Index

STAS qubic & qubic pro	36
STAS v-tense & h-tense	38
STAS v-tense & h-tense accessories & possibilities	40
STAS papergrip	44
STAS papergrip hanger	45
STAS name tag	46
STAS wall strip	47
STAS paperrail	48
STAS panel hooks	49
STAS picture hits	50
STAS set up	51
STAS poster strips and poster snaps	52
STAS suspended ceiling hooks	53
STAS dibond hangers	53

STAS qubic & qubic pro

flexible in all directions

The STAS qubic is a compact and square hanging system, suitable for hard walls such as stone or concrete. Do not underestimate the STAS qubic by its size, because that is exactly what's so convenient about this hanging system.

The STAS qubic is suitable for one hanging point and can be easily installed in the more difficult places. Think of a stairwell, a slanted ceiling or a pillar. The STAS qubic can be mounted in many different ways and therefore the cords can also be hooked in many possible ways.

The versatility of the STAS qubic makes it an indispensable hanging system for difficult places.

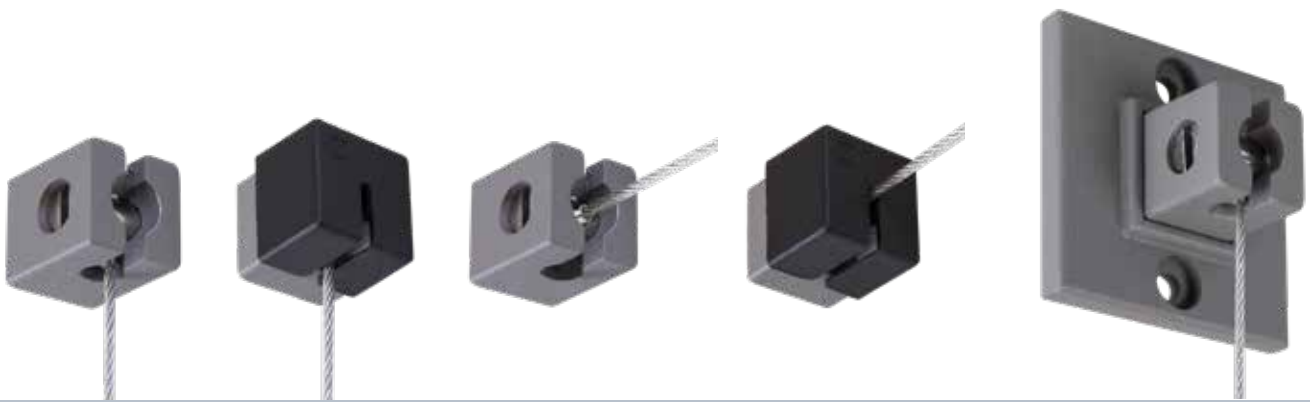

wall mounting STAS qubic

wall mounting STAS qubic pro



Features qubic

Dimensions	22 x 22 x 24 mm
Colour	alu textured
Material	aluminium
Installation	ceiling- and wall mounting
Weight capacity	15 kg
Warranty	5 years

For matching hooks and cords, see page 31.
See page 42 for combining with STAS v-tense & h-tense.

Parts



STAS qubic
TCS1000



STAS qubic
endcap black
TCS9002



STAS screw qubic
SJ30200



STAS plug
SR50700

NEW

The STAS qubic pro works the same as the STAS qubic, but is suitable for soft walls such as plaster and sand-lime brick. The mounting plate can be installed with 2 screws which provides extra reinforcement of the STAS qubic pro in the soft wall.

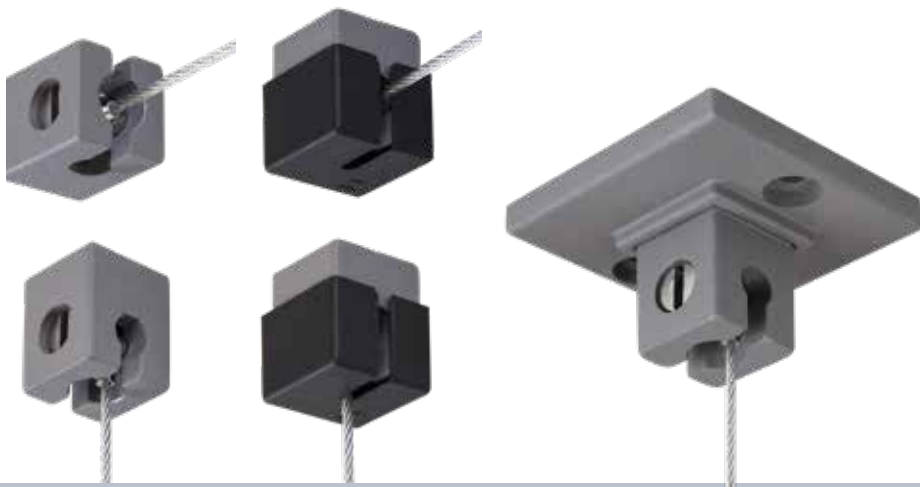

ceiling mounting STAS qubic

ceiling mounting STAS qubic pro

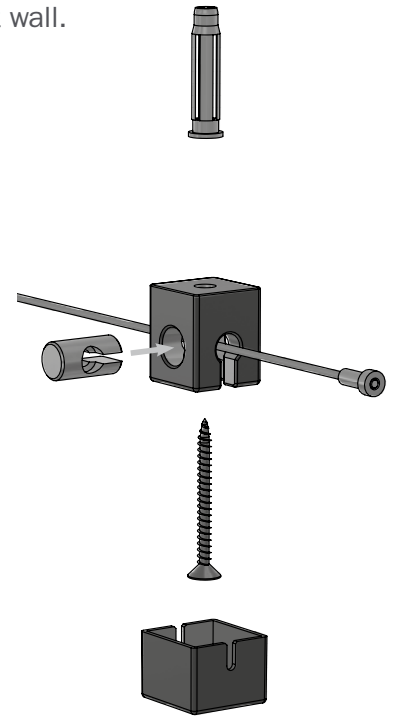

Features qubic pro

Dimensions	50 x 50 x 28 mm
Colour	alu textured
Material	aluminium
Installation	ceiling- and wall mounting
Weight capacity	20 kg
Warranty	5 years

For matching hooks and cords, see page 31.
See page 42 for combining with STAS v-tense & h-tense.



STAS qubic pro
TCS1010



STAS screw qubic pro
SJ30100



STAS qubic endcap black
TCS9002



STAS plug SR50700

STAS v-tense & h-tense combine endlessly

NEW

The tensioned cable system can be used flexibly and mounted on walls or ceiling. Horizontally, vertically and diagonally! The possibilities in combination with the STAS qubic, the STAS evoluon and the other STAS rail systems are therefore endless. Consider, for example, applications for the creation of shop windows, the presentation of houses in the real estate sector, displaying menus in restaurants or hanging material in schools or in the office.

STAS v-tense (vertical)

The STAS v-tense is, together with the STAS h-tense, part of the tensioned cable system assortment. The STAS v-tense can be used vertically and is equipped with a glider on both sides. The cables are easy to tighten. In addition, an extra spring has been added to the STAS v-tense so that the wire still offers enough elasticity to hook into a rail with a hook. The STAS v-tense can be combined with various STAS rail systems, the STAS qubic and the STAS evoluon to easily create a wall presentation.

* Also available in a version with a glider on one side and a STAS cobra on the other for hanging options with a STAS rail.



Features v-tense

Dimensions	26 x 3 mm
Length	150 , 300, 450 cm
Colour	alu structure
Material	aluminium
Installation	wall- and ceiling mounting (in combination with the STAS rail, STAS evoluon and STAS qubic)
Warranty	5 years

Content

STAS v-tense

TSBV150 150 cm
TSBV300 300 cm
TSBV450 450 cm



Consult the separate product sheet for combinations and options.

STAS h-tense (horizontal)

The STAS h-tense is, together with the STAS v-tense, part of the tensioned cable system assortment. The STAS h-tense can be used horizontally and is equipped with a glider on both sides. The wire is easy to tighten. The STAS h-tense can be combined with the STAS qubic to easily create a wall presentation.

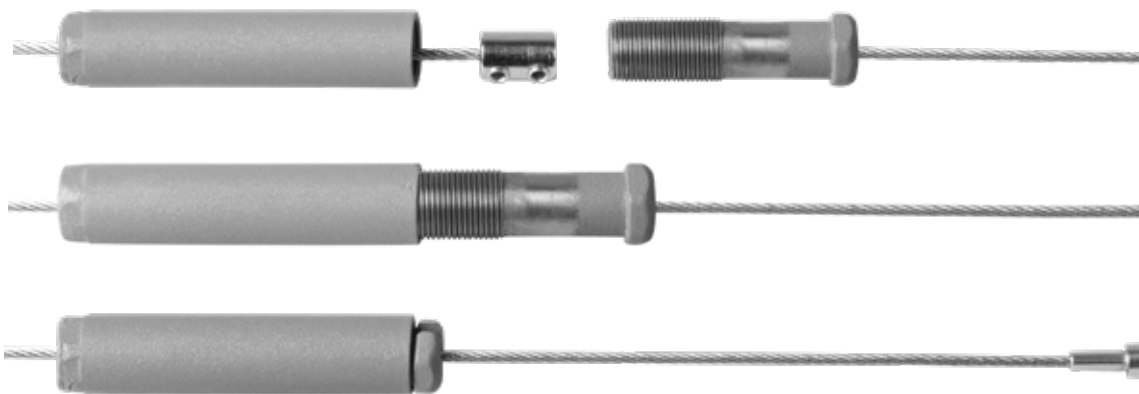

Features h-tense

Dimensions	26 x 3 mm
Length	150 , 300, 450 cm
Colour	alu structure
Material	aluminium
Installation	wall- and ceiling mounting (in combination with the STAS qubic)
Warranty	5 years



Content



STAS h-tense
TSBH150 150 cm
TSBH300 300 cm
TSBH450 450 cm

Consult the separate product sheet for combinations and options.

STAS v-tense & h-tense accessories & possibilities

NEW

STAS accessories



STAS frame clamp (4.5 mm)
TCS30001

STAS frame clamp (4.5 mm)

The STAS frame clamp can be screwed onto a tensioned wire. When 2 tensioned wires are mounted next to each other with both a STAS frame clamp, a frame or other material (minimal 1 mm and maximal 4.5 mm thick) can be clamped between them.



STAS frame connector (4.5 mm)
TCS30002

STAS frame connector (4.5 mm)

The STAS frame connector can be screwed onto a tensioned wire. The double opening allows several frames or other material (minimal 1 mm and maximal 4.5 mm thick) to be placed next to each other.



STAS tense-frame
TCS30010

STAS tense-frame

The A4 size frame comes with 4 STAS frame clamps (4.5 mm). When 2 tensioned wires are mounted next to each other, the STAS tense frame can be placed between these wires. The frame can be opened at the top so that material can be placed inside. Think, for example, of applications for advertisements or the presentation of houses in real estate. The frame can be closed magnetically.



STAS frame clamp (8.5 mm)
TCS30003

STAS frame clamp (8.5 mm)

The STAS frame clamp can be screwed onto a tensioned wire. When 2 tensioned wires are mounted next to each other with both a STAS frame clamp, a frame or other material (minimal 4 mm and maximal 8.5 mm thick) can be clamped between them.



STAS frame connector (8.5 mm)
TCS30004

STAS frame connector (8.5 mm)

The STAS frame connector can be screwed onto a tensioned wire. The double opening allows several frames (minimal 4 mm and maximal 8.5 mm thick) to be placed next to each other.



STAS shelf clamp (8.5 mm)
TCS30005

STAS shelf clamp (8.5 mm)

The STAS shelf clamp can be screwed on the STAS steel cable with glider (p.31). When 4 sets of STAS steel cables with glider are mounted with 4 STAS shelf clamps, a STAS shelf can be placed in between to create shelves.



STAS shelf connector (8.5 mm)
TCS30006

STAS shelf connector (8.5 mm)

The STAS shelf connector can be screwed onto the STAS steel cable with glider. Thanks to the double opening, several STAS shelves can be placed next to each other in order to create shelves.



STAS shelf 20 x 30 cm
TCS30025

STAS shelf

The STAS shelf is a plexiglass shelf of 20 x 30 cm. With the help of 4 STAS shelf clamps, this shelf can be attached to 4 sets of STAS steel cable with glider (p.31) in order to create shelves. (other dimensions available upon request)



STAS security hook
HA30600

STAS security hook

The STAS security hook is a hook that can be used with the STAS v-tense. The STAS security hook can be placed before as well as after mounting the tensioned wire by means of a rotary wheel behind the hook.



STAS signage clip
TCS30007

STAS signage clip

The STAS signage clip can be screwed onto a STAS steel cable with glider and then placed in the STAS cubic. Signs with a minimum thickness of 2 mm and a maximum of 7 mm can be clamped in the STAS signage clip.

* Can also be used with STAS steel cable with loop and STAS drop ceiling hook.



STAS metal clothespin
MC10100

STAS metal clips

These metal clips are suitable for hanging various materials on the STAS h-tense. Think of hanging alphabet letter tiles, posters, drawings, decorations, all kinds of papers and light objects.



STAS distance clamp
TCS30009

STAS distance clamp

The STAS distance clamp can be screwed onto a tensioned wire. The front part can be loosened, after which this part can be pushed through the drill holes of a frame, plate or other object. The 2 pieces can be tightened again. Due to the extended back, the STAS distance clamp ensures that the wall object hangs stable and with a same distance from the wall.



STAS tense led-frame
TCS30015

STAS tense LED frame

The A4 size LED frame comes with 4 attached clamps. When 2 tensioned wires are mounted next to each other, the STAS tense LED frame can be placed between the wires. Material can be placed in the frame by removing and replacing a transparent magnetic plate.

STAS tense 12V power (60W)

The STAS tense 12V power is an adapter that can be used to power the STAS tense LED frame with 60W power. A maximum of 12 LED frames* can be connected to this adapter.

* max. 12 LED frames connected on 2 tensioned wires. If you want to use more than 12 LED frames and / or more than 2 tensioned wires, it is necessary to use multiple adapters.



STAS tense 12V power
VT30600

Applications



STAS frame clamp
(4.5 mm)



STAS frame connector
(4.5 mm)



STAS frame clamp
(8.5 mm)



STAS frame connector
(8.5 mm)



STAS shelf clamp
(8.5 mm)

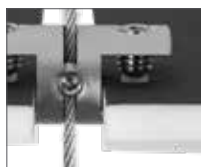

STAS shelf connector
(8.5 mm)



STAS signage clip



STAS distance clamp

STAS v-tense & h-tense accessories & options

NEW

Options STAS v-tense



STAS qubic, STAS v-tense, STAS tense frame & STAS frame clamps

STAS qubic, STAS v-tense, STAS tense frame & STAS frame clamps

STAS qubic, STAS v-tense, STAS evoluon, STAS tense frame & STAS frame clamps

STAS evoluon, STAS v-tense, STAS security hook & STAS kliq frame

Options STAS signage clip



STAS signage clip & steelcable with loop.
(to be used with the STAS suspended ceiling hook with loop)

STAS signage clip, steelcable with glider & STAS qubic.





STAS cliprail, STAS qubic, STAS v-tense
STAS security hook & decorative photo frames



STAS j-rail, STAS v-tense, STAS frame clamps & presentation board

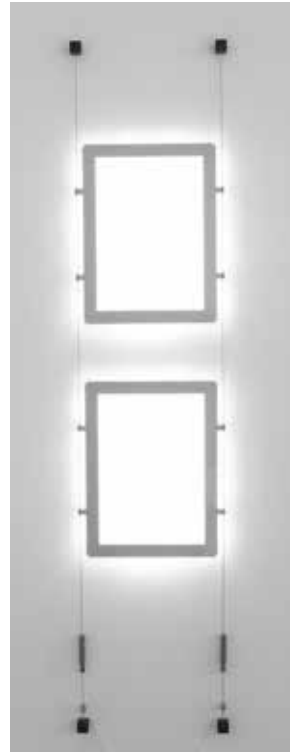

STAS qubic, STAS v-tense & STAS tense LED frame



STAS qubic ceiling mounting, STAS shelf clamp & STAS shelves



Options STAS h-tense



STAS h-tense, STAS qubic, STAS metal clips, alphabet letter tiles



STAS h-tense, STAS qubic, STAS tense frame & STAS frame clamps

STAS papergrip

twice as handy



STAS papergrip is one rail with two applications. Thanks to a handy internal strip, papers can be easily clipped into the rail or removed. In addition, cards (etc.) can be placed in the special ledge on top of the rail.

STAS papergrip is suitable for thick and thin paper and it can even grab hold of thin magazines and laminated paper. Separate rail pieces can be connected to create a hanging system spanning the entire wall.

Optional: click specially designed STAS papergrip hooks onto the rail to hang up additional small items, like keys, or for example a STAS magnet set 2-in-1. A STAS papergrip hook has a weight capacity of 3 kg.



Features



Dimensions	13.3 mm x 45 mm
Length	50, 100, 150 or 200 cm
Colour	white, white textured, black textured or alu textured (more colours on request)
Material	rail: aluminium with powder coating inside strip: polyurethane foam core and polyethylene coating layer
Installation	standard with railclips (3 per metre) optional with magnetic tape or double-sided tape
Warranty	5 years

Parts



STAS papergrip white
PG10105 50 cm
PG10110 100 cm
PG10115 150 cm
PG10120 200 cm



STAS papergrip white textured
PG15005 50 cm
PG15010 100 cm
PG15015 150 cm
PG15020 200 cm



STAS papergrip alu textured
PG30105 50 cm
PG30110 100 cm
PG30115 150 cm
PG30120 200 cm



STAS papergrip black textured
PG20105 50 cm
PG20110 100 cm
PG20115 150 cm
PG20120 200 cm



STAS papergrip end cap
PG90001 white
PG90003 alu
PG90002 black



STAS papergrip hook
HA40410 white
HA40412 alu
HA40411 black



STAS railclip
RD40100
(metal, 3 per m²)



STAS rail connector
RD40200
(metal)



STAS screw torx
SR30600



STAS plug
SR50700

STAS papergrip hanger

secure hanging



The STAS papergrip hanger has been specially developed for hanging a whiteboard (with a max. size of 90x120 cm) on the STAS papergrip (mounted with screws), by means of 2 STAS papergrip hangers. The hangers are attached to the whiteboard with screws and then placed on the STAS papergrip, after which the whiteboard is easy to install and move. In addition, the hanger is equipped with a safety lock, so that it cannot be pushed out of the rail when force is exerted on the whiteboard. By mounting stabilizing caps the whiteboard remains stable. This makes the STAS papergrip hanger very suitable for the safe hanging of a whiteboard in educational institutions.

In addition to the whiteboard, other objects can also be hung on the STAS papergrip hanger. For suspending light items such as a small clock, the hanger can be attached with double-sided tape.

Features

Dimensions	3.5 x 9.5 cm
Colour	white
Material	steel with powder coating
Installation	to the product to be hung
Weight capacity	per hanger per meter: 20 kg (when papergrip is mounted with screws) papergrip hanger set: whiteboard of max. 90 x 120 cm
Warranty	5 years



Parts



STAS papergrip hanger
HA40110



STAS papergrip hanger stabilisation set
PG40110



STAS name tag

a place for every name

NEW



The STAS name tag is a clip that can be clicked on the STAS papergrip. Paper can be placed inside this clip. With the STAS name tag, the names of the children can be displayed in the classroom or in your home*.

* Templates for printing out the name cards are available on request. Please contact our sales department for more information.



Features

Dimensions	8,7 x 3,7 x 6 mm
Colour	black
Material	plastic
Installation	to attach on the papergrip



STAS name tag
PG20007

STAS wall strip getting creative with hook and loop



Hanging pictures by means of hook and loop fasteners? Does that work? Yes, it does! In fact, STAS wall strip is ideal for hanging pictures stably and horizontally, as well as for creating wall collages.

Stick the hook and loop stickers to the back of your picture frame. Then hook the wall strip into your STAS rail* by its cobra hook. Finally, simply “stick” the frame onto the wall strip. The remainder of the strip can easily be cut off.

STAS wall strip makes a statement on your walls and doesn't try to hide from sight. Feel free to play with the options: hang pictures from two strips, create collages or stick other objects, like cards, to the strip.

* With the exception of the STAS wooden rails, STAS j-rail (max), STAS evoluon and STAS plaster rail.

Features

Dimensions	cobra hook: 2.8 cm wide x 1.3 cm high, strip: 2 cm wide
Length	200 cm
Colour	white
Material	synthetic hook with hook and loop fastener strip and stickers
Weight capacity	5 kg per strip
Warranty	5 years



STAS wall strip
WS40400 200 cm
1 hook and loop strip
10 hook and loop stickers

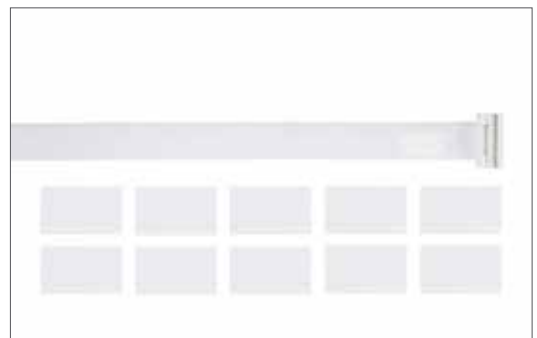

STAS paperrail

marbles put to good use



STAS paperrail is an aluminium rail for hanging up loose papers. The rail contains glass marbles, which press against the paper, creating a handy clamping mechanism.

You can slide drawings, announcements and photos into the rail with a single move and remove them again without any damage to the paper. Papers can also be placed on top of the rail.

Ideal for use in classrooms, offices, restaurants and even at home above the kitchen table.

The STAS paperrail is mounted directly onto the wall.

Features

Dimensions	21 x 48.5 mm
Length	50, 100 or 200 cm
Colour	white or alu (more colours on request)
Material	aluminium
Installation	wall mountable, not adjoining to ceiling
Weight capacity	suitable for paper and cardboard
Warranty	5 years



Parts

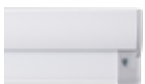

STAS paperrail white
KN10005 50 cm
KN10010 100 cm
KN10020 200 cm



STAS paperrail alu
KN30005 50 cm
KN30010 100 cm
KN30020 200 cm



STAS plug
SR50700



STAS screw torx
SR30600



STAS paperrail connector set
KN30100

STAS panel hooks

the classic hanging solution

Panel hooks offer a practical solution when you need to hang objects from wall panels, partition walls, doors, cornices, etc.

They are very easy to combine with STAS cords with a loop and a STAS zipper or STAS smartspring. This way, you can create a complete hanging system in an instant, but without the aluminium rail.



Products

STAS offers many different types of panel hooks:



STAS panel hook white 11 mm
HW10300



STAS panel hook white 16 mm
HW10400



STAS panel hook white 18 mm
HW10600



STAS panel hook white 21 mm
HW10500



STAS panel hook white 26 mm
HW10700



STAS panel hook white 31 mm
HW10800



STAS panel hook alu intersect
HW30700



STAS panel hook alu lux window frame
HW30800



STAS panel hook transparent alcoa
HW50100



STAS panel hook alu vervol type 1
HW30300*



STAS panel hook alu vervol type 2
HW30400



STAS panel hook alu sepa normal
HW30500



STAS panel hook askon chrome
HW50400



STAS panel hook PE transparent
HW50500



STAS panel hook maars
HW50600



STAS moulding hook white
HW10200



STAS moulding hook alu
HW30200



STAS moulding hook gold
HW60200



* Only available in combination with STAS perlon cord with loop and zipper.

STAS picture hits

invisible connection



STAS picture hits are transparent plastic clips that allow you to easily connect photos, cards and other lightweight decorative items to each other and to your STAS rail.

The first clip is screwed into your STAS rail. Then you can slide a photo, card or other decoration into the clip. By sliding a new STAS picture hit on the bottom or side, you can attach another decoration. Step by step, you can create your own unique collage.

STAS picture hits are ideal for temporary or changing decorations, for instance photos, Christmas cards, birthday cards, vacation snaps, streamers and other party or seasonal attributes.

Tip: place the transparent distance strips between the rail and your decoration to hang it a little lower, for example at eye level.



Features



Colour	transparent
Material	plastic
Installation	to a STAS rail*
Weight capacity	suitable for paper and thin cardboard
Warranty	5 years

* with the exception of STAS j-rail (max), STAS wooden rail, STAS plasterrail and STAS evoluon



STAS picture hits
BM20350

Contents per set

20 STAS picture hits (clips)

2 STAS pet strips 50 cm (transparent distance strips)

STAS set up placing instead of hanging



Sometimes it's a better idea to rest pictures and photo frames on something instead of hanging them up. That's when the STAS set up comes in handy.

This stylish rail measuring 145 cm in length has a neutral design and can be used in many ways.

Features

Dimensions	145 cm long, 8 cm deep with a 1.7 cm high raised edge
Colour	white or alu
Material	aluminium
Installation	wall mountable with 6 screws
Weight capacity	15 kg/m
Warranty	5 years



Parts



STAS set up white
RR10120 145 cm



STAS set up alu
RR30120 145 cm



**STAS screw
flush head white**
SJ10100



**STAS screw
flush head alu**
SJ30100



STAS plug
SR50700

STAS poster strips and poster snaps hanging without framing



STAS poster strip

The STAS poster strip is a classic poster strip in transparent plastic and is designed to lock posters into position so as to hang them neatly, simply and stylishly. The poster can be slid into the strip from the side.

STAS poster snap

The STAS poster snap is a more luxurious variant to the plastic poster strip, made from high-grade aluminium. This makes the system ideally suited for presenting canvases, fabrics and heavy posters without taking anything away from the style.

The poster does not have to be inserted from the side: simply click the STAS poster snap open and shut at the top and the bottom.



Features STAS poster strip

Dimensions	6 x 13 mm
Length	30, 42, 50, 60, 70, 84 or 100 cm
Colour	transparent
Material	plastic
Weight capacity	suitable for paper and cardboard
Warranty	5 years

Features STAS poster snap

Dimensions	16 x 27 mm
Length	50, 70 or 100 cm
Colour	alu
Material	aluminium
Weight capacity	suitable for heavier posters, canvas and fabrics
Warranty	5 years

STAS poster strip set transparent

PS50030 30 cm	PS50070 70 cm
PS50042 42 cm	PS50084 84 cm
PS50050 50 cm	PS50110 100 cm
PS50060 60 cm	

STAS poster snap set alu

PS30050 50 cm
PS30070 70 cm
PS30100 100 cm

STAS suspended ceiling hooks

No more messing around with bending paper clips or tying strings. With the white STAS suspended ceiling hooks, you can hang up children's crafts, festive decorations or lesson material to the suspended ceiling in an instant. All you need to do is slide the hook over the runners of the suspended ceiling.

STAS suspended ceiling hooks are available with an eyelet and with a hook.



STAS suspended ceiling hook white
HA10100 max 5 kg



STAS suspended ceiling hook for loop
HA10200 max 5 kg



STAS dibond hangers

STAS dibond hangers are self-adhesive steel plates with a hook, which can be affixed onto the back of flat panels. That way, the panel is equipped with a hook, with which it can then be suspended from a picture hanging system.

Extremely suitable for art and photos on dibond or mirrors and frames with a dibond backside.



STAS dibond hanger
set 3 kg
BS30300



STAS dibond hanger
set 6 kg
BS30600



STAS self-adhesive
distance caps round
13 mm (per 4 pieces)
MB10080

STAS clocktica

timeless design

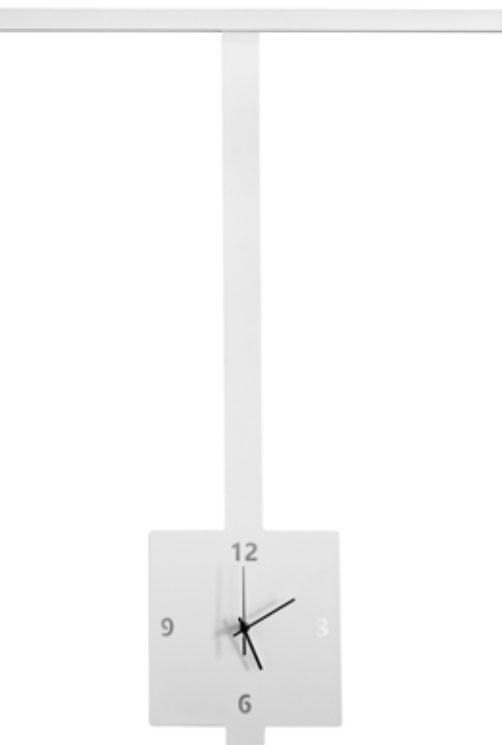

The STAS clocktica is a silent design clock that can be hooked into almost any STAS picture rail system.* The clock works on batteries and is made of sturdy steel. The STAS clocktica is suitable for educational institutions, for in the office or for your own home. Complete your interior with this flexible design clock!

* With the exception of the STAS wooden rails, STAS j-rail (max), STAS evoluon and STAS plaster rail.



Features

Dimensions	25 cm wide
Length	43 cm, 95 cm
Colour	white textured, RVS, black textured
Material	steel, powdercoated steel
Warranty	5 years

STAS clocktica white textured

KH40430W 43 cm
KH40950W 95 cm

STAS clocktica RVS

KH40430R 43 cm
KH40950R 95 cm

STAS clocktica black textured

KH40430Z 43 cm
KH40950Z 95 cm

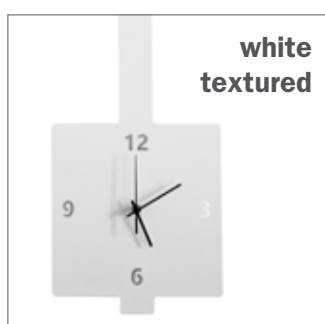

white
textured

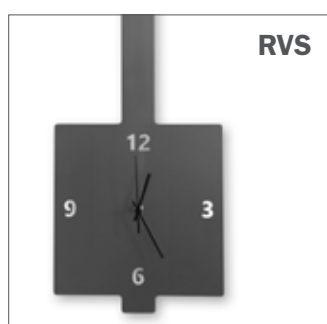

RVS



black
textured



STAS tunica

turn your wall into storage space

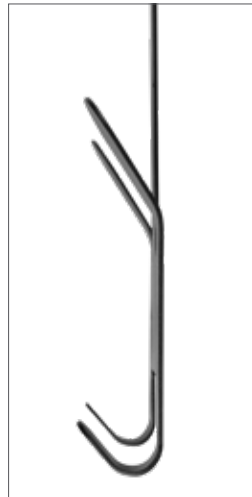

STAS tunica is a stylish coat hook system that easily fits into almost all STAS rails*. Now your wall not only has a decorative purpose, but a practical one as well. The coat hook is sturdy, but also easily and endlessly moveable.

The STAS tunica has a neutral design and features two coat hooks.

* With the exception of the STAS wooden rails, STAS j-rail (max), STAS evoluon and STAS plaster rail.



STAS tunica white
KH40095W 95 cm



STAS tunica black
KH40095Z 95 cm



Features

Dimensions	15 cm wide x 5,2 cm depth mounting strip: 5 cm wide
Length	95 cm
Colour	white, black (more colours on request)
Material	powdercoated steel with 2 hooks
Weight capacity	10 kg per hook
Warranty	5 years

STAS product index

article code	product description	page nr.	article code	product description	page nr.	article code	product description	page nr.		
Rail systems			VD10400	cliprail pro corner cap white	8	TCS9020	bending mold evoluon	14		
STAS minirail			VD30400	cliprail pro corner cap alu	8	SJ30300	evoluon screw	14		
RM10120	minirail white 200 cm	5	RD40100	railclip (metal, 3 per m ²)	8	SR50700	plug 6 x 30 mm hard / soft wall	14		
RM10130	minirail white 300 cm	5	RD40200	rail connector (metal)	8	STAS drywallXpress (with STAS cliprail)				
RM10600	minirail white 600 cm	5	SR30100	screw	8	RD40400	Drywall clip	15		
RM30120	minirail alu 200 cm	5	SR30600	screw torx	8	RD40500	Push plate	15		
RM30130	minirail alu 300 cm	5	SR50700	plug 6 x 30 mm hard / soft wall	8	RT40200	DrywallXpress connector	15		
RD10200	minirail rail connector	5	STAS plasterrail			9	STAS separate rail parts			
RY10200	minirail combi cap** white	5	RS30250	plasterrail 250 cm	9	PS50105	rail installation kit 2 m ² (6 x clip/screw/plug)			
RY30200	minirail combi cap** alu	5	RS30251	plasterrail connector	9	RD10100	railclip plastic			
SR10000	minirail clipscrew (metal, 3 per m ²)	5	RS30260	plasterrail cord for plastering 3 mm, 20 metre per roll	9	Rail systems with lighting				
SR10200	minirail clipscrew torx	5	STAS j-rail			10	STAS multirail			
SR50700	plug 6 x 30 mm hard / soft wall	5	RJ10120	j-rail white 200 cm (4 holes per m ²)	10	VH10200	multirail white 200 cm	17		
STAS cliprail			6	RJ10130	j-rail white 300 cm (4 holes per m ²)	10	VH10300	multirail white 300 cm	17	
RC10320	cliprail white 200 cm	6	RJ30120	j-rail alu 200 cm (4 holes per m ²)	10	VH30200	multirail alu 200 cm	17		
RC10330	cliprail white 300 cm	6	RJ30130	j-rail alu 300 cm (4 holes per m ²)	10	VH30300	multirail alu 300 cm	17		
RC10360	cliprail white 600 cm	6	SJ10100	j-rail screw flush head white	10	VE10200	multirail end cap white	17		
RC30120	cliprail alu 200 cm	6	SJ30100	j-rail screw flush head alu	10	VE30200	multirail end cap alu	17		
RC30130	cliprail alu 300 cm	6	SR50700	plug 6 x 30 mm hard / soft wall	10	VD10400	multirail corner cap white	17		
RD10300	cliprail end cap white	6	STAS j-rail max			11	VD30400	multirail corner cap alu	17	
RD30300	cliprail end cap alu	6	RJ10220	j-rail max white 200 cm (4 holes per m ²)	11	VF50200	multirail conductor 12 V straight	17		
RD10400	cliprail corner cap white	6	RJ10230	j-rail max white 300 cm (4 holes per m ²)	11	VF50100	multirail conductor 12 V corner	17		
RD30400	cliprail corner cap alu	6	RJ30220	j-rail max alu 200 cm (4 holes per m ²)	11	RD40100	railclip (metal, 3 per m ²)	17		
RD40100	railclip (metal, 3 per m ²)	6	RJ30230	j-rail max alu 300 cm (4 holes per m ²)	11	RD40200	rail connector (metal)	17		
RD40200	rail connector (metal)	6	SJ10200	j-rail max screw sunk head white	11	SR30100	screw	17		
SR30100	screw	6	SJ30200	j-rail max screw sunk head alu	11	SR30600	screw torx	17		
SR30600	screw torx	6	SR50700	plug 6 x 30 mm hard / soft wall	11	SR50700	plug 6 x 30 mm hard / soft wall	17		
SR50700	plug 6 x 30 mm hard / soft wall	6	STAS u-rail			12	STAS multirail max			
STAS cliprail max			7	RP10120	u-rail white 200 cm (8 holes per m ²)	12	VC10420	multirail max white 200 cm	18	
RC10220	cliprail max white 200 cm	7	RP10130	u-rail white 300 cm (8 holes per m ²)	12	VC10430	multirail max white 300 cm	18		
RC10230	cliprail max white 300 cm	7	RP20120	u-rail black 200 cm (8 holes per m ²)	12	VC30420	multirail max alu 200 cm	18		
RC30220	cliprail max alu 200 cm	7	RP20130	u-rail black 300 cm (8 holes per m ²)	12	VC30430	multirail max alu 300 cm	18		
RC30230	cliprail max alu 300 cm	7	RP30120	u-rail alu 200 cm (8 holes per m ²)	12	RM10420	prorail max white 200 cm *	18		
RY10100	cliprail max combi cap** white	7	RP30130	u-rail alu 300 cm (8 holes per m ²)	12	RM10430	prorail max white 300 cm *	18		
RY30100	cliprail max combi cap** alu	7	SP10100	u-rail screw white	12	VE10400	multirail max end cap white	18		
RD40100	railclip (metal, 3 per m ²)	7	SP20100	u-rail screw black	12	VE30400	multirail max end cap alu	18		
RD40200	rail connector (metal)	7	SP30100	u-rail screw alu	12	VD20500	multirail max corner cap white	18		
SR30100	screw	7	STAS windsor & riva			13	VD30500	multirail max corner cap alu	18	
SR30600	screw torx	7	RP50224	windsor 240 cm	13	VF50200	multirail conductor 12 V straight	18		
SR50700	plug 6 x 30 mm hard / soft wall	7	RP50124	riva 240 cm	13	VF50100	multirail conductor 12 V corner	18		
STAS cliprail pro			8	STAS evoluon			14	RD40100	railclip (metal, 3 per m ²)	18
VC10200	cliprail pro white 200 cm	8	TCS30020	STAS evoluon 200 cm	14	RD40200	rail connector (metal)	18		
VC10300	cliprail pro white 300 cm	8	TCS9012	distance holder evoluon	14	SR30100	screw	18		
VC30200	cliprail pro alu 200 cm	8	TCS9016	STAS evoluon hook	14	SR30600	screw torx	18		
VC30300	cliprail pro alu 300 cm	8	STAS evoluon			14	SR50700	plug 6 x 30 mm hard / soft wall	18	
VE10200	cliprail pro end cap white	8	TCS30020	STAS evoluon 200 cm	14					
VE30200	cliprail pro end cap alu	8	TCS9012	distance holder evoluon	14					
			TCS9016	STAS evoluon hook	14					

** combi cap: 2 x end cap/1 x corner cap

article code	product description	page nr.
STAS multirail crown		19
RC10420	multirail crown white 200 cm (4 holes per m ²)	19
RC10430	multirail crown white 300 cm (4 holes per m ²)	19
RH10420	prorail crown white 200 cm (4 holes per m ²) *	19
RH10430	prorail crown white 300 cm (4 holes per m ²) *	19
RD20500	multirail crown corner connector white	19
RD20400	multirail crown rail connector	19
VF50200	multirail conductor 12 V straight	19
VF50100	multirail conductor 12 V corner	19
SJ10200	multirail crown screw	19
SR50700	plug 6 x 30 mm hard / soft wall	19

STAS multirail flat		20
RC10520	multirail flat white 200 cm (4 holes per m ²)	20
RC10530	multirail flat white 300 cm (4 holes per m ²)	20
RH10520	prorail flat white 200 cm (4 holes per m ²) *	20
RH10530	prorail flat white 300 cm (4 holes per m ²) *	20
RD20500	multirail flat corner connector white	20
RD20400	multirail flat rail connector	20
VF50200	multirail conductor 12 V straight	20
VF50100	multirail conductor 12 V corner	20
SJ10200	multirail flat screw	20
SR50700	plug 6 x 30 mm hard / soft wall	20

STAS u-rail multi		21
VP10200	u-rail multi white 200 cm (8 holes per m ²)	21
VP10300	u-rail multi white 300 cm (8 holes per m ²)	21
VP20200	u-rail multi black 200 cm (8 holes per m ²)	21
VP20300	u-rail multi black 300 cm (8 holes per m ²)	21
VP30200	u-rail multi alu 200 cm (8 holes per m ²)	21
VP30300	u-rail multi alu 300 cm (8 holes per m ²)	21
VF50200	multirail conductor 12 V straight	21
VF50100	multirail conductor 12 V corner	21
SP10100	u-rail screw white	21
SP20100	u-rail screw black	21
SP30100	u-rail screw alu	21

STAS multirail accessories		22
VA10500	multirail fixture classic white 50 cm	22
VA10700	multirail fixture classic white 70 cm	22
VA30500	multirail fixture classic chrome 50 cm	22
VA30700	multirail fixture classic chrome 70 cm	22
VA30365	multirail fixture sirius chrome 40 cm	22
VA30465	multirail fixture sirius chrome 50 cm	22
VA30665	multirail fixture sirius chrome 65 cm	22
VA30770	multirail fixture signo chrome 70 cm	22
VL10200	multirail LED spot 3,5 W 27°	23
VL10700	multirail powered 4 W	23
VL10900	multirail LED spot 3,5 W 95°	23
VT20500	multirail adapter 18 W	24

article code	product description	page nr.
VT20400	multirail adapter 60 W	24
VT20300	multirail adapter 96 W	24

Hooks and cords for rail systems 25

STAS hooks and cords		26
HA30900	smartspring (4 kg perlon)	26
HA30501	zipper (15 kg perlon + 20 kg steel)	26
HA30530	zipper pro (15 kg perlon + 20 kg steel)	26
CP10110	cobra + perlon cord 100 cm	26
CP10115	cobra + perlon cord 150 cm	26
CP10120	cobra + perlon cord 200 cm	26
CP10125	cobra + perlon cord 250 cm	26
CP10130	cobra + perlon cord 300 cm	26
CP10140	cobra + perlon cord 400 cm	26
SC10110	cobra + steelcable 100 cm	26
SC10115	cobra + steelcable 150 cm	26
SC10120	cobra + steelcable 200 cm	26
SC10125	cobra + steelcable 250 cm	26
SC10130	cobra + steelcable 300 cm	26
SC10140	cobra + steelcable 400 cm	26
SC10220	cobra + steelcable white 200 cm (10 kg zipper)	26
SC20220	cobra + steelcable black 200 cm (10 kg zipper)	26
BM20330	blister 2 x smartspring	
BM20340	blister 2 x zipper	
BM20310	blister 2 x cobra + perlon cord 150 cm	
BM20320	blister 2 x cobra + steelcable 150 cm	
BM10280	blister cobra+perlon cord 150 cm+smartspring	
BM10230	blister cobra+perlon cord 150 cm+zipper	
BM10290	blister cobra+steelcable 150 cm+zipper	
PK10100	perlon cord on roll 100 m ²	

STAS j-rail hooks, cords and rods 27

HA30900	smartspring (4 kg perlon)	27
HA30501	zipper (15 kg perlon + 20 kg steel)	27
HA30530	zipper pro (15 kg perlon + 20 kg steel)	27
PH10110	perlon cord with disk 100 cm	27
PH10115	perlon cord with disk 150 cm	27
PH10120	perlon cord with disk 200 cm	27
PH10125	perlon cord with disk 250 cm	27
PH10130	perlon cord with disk 300 cm	27
HR10600	j-rail cylinder hook white	27
HR30600	j-rail cylinder hook alu	27
S010110	j-rail rod 3 mm white 100 cm	27
S010115	j-rail rod 3 mm white 150 cm	27
S010120	j-rail rod 3 mm white 200 cm	27
S010130	j-rail rod 3 mm white 300 cm	27
S030110	j-rail rod 3 mm alu 100 cm	27
S030115	j-rail rod 3 mm alu 150 cm	27
S030120	j-rail rod 3 mm alu 200 cm	27
S030130	j-rail rod 3 mm alu 300 cm	27

article code	product description	page nr.
HA30700	j-rail spring hook for rod 3 mm (15 kg)	27
HR10400	j-rail S-hook white (for cord with loop)	27
HR30400	j-rail S-hook chrome (for cord with loop)	27

STAS j-rail max hooks en rods 28

SM10110	j-rail max rod 4x4 white 100 cm	28
SM10115	j-rail max rod 4x4 white 150 cm	28
SM10120	j-rail max rod 4x4 white 200 cm	28
SM10125	j-rail max rod 4x4 white 250 cm	28
SM30110	j-rail max rod 4x4 alu 100 cm	28
SM30115	j-rail max rod 4x4 alu 150 cm	28
SM30120	j-rail max rod 4x4 alu 200 cm	28
SM30125	j-rail max rod 4x4 alu 250 cm	28
SM10210	j-rail max rod 4x10 white 100 cm	28
SM10215	j-rail max rod 4x10 white 150 cm	28
SM10220	j-rail max rod 4x10 white 200 cm	28
SM10225	j-rail max rod 4x10 white 250 cm	28
HA40600	j-rail max hook for rod 4x4 (40 kg)	28
HA40500	j-rail max hook for rod 4x10 (100 kg)	28
BK10200	4x4 security set, collar + cap	28
HA40700	j-rail max security hook (40 kg)	28

STAS plasterrail hooks and cords 29

HA30900	smartspring (4 kg perlon)	29
HA30501	zipper (15 kg perlon + 20 kg steel)	29
HA30530	zipper pro (15 kg perlon + 20 kg steel)	29
RS30270	plasterrail S-hook chrome (for cord with loop)	29
PA10150	perlon cord with plasterrail hook 150 cm	29
PL10110	perlon cord with loop 100 cm	29
PL10115	perlon cord with loop 150 cm	29
PL10120	perlon cord with loop 200 cm	29
PL10125	perlon cord with loop 250 cm	29
PL10130	perlon cord with loop 300 cm	29
SL10110	steelcable with loop 100 cm	29
SL10115	steelcable with loop 150 cm	29
SL10120	steelcable with loop 200 cm	29
SL10125	steelcable with loop 250 cm	29
SL10130	steelcable with loop 300 cm	29

STAS windsor & riva hooks and cords 30

HA30900	smartspring (4 kg perlon)	30
HA30501	zipper (15 kg perlon + 20 kg steel)	30
HA30530	zipper pro (15 kg perlon + 20 kg steel)	30
PL10110	perlon cord with loop 100 cm	30
PL10115	perlon cord with loop 150 cm	30
PL10120	perlon cord with loop 200 cm	30
PL10125	perlon cord with loop 250 cm	30
PL10130	perlon cord with loop 300 cm	30
SL10110	steelcable with loop 100 cm	30
SL10115	steelcable with loop 150 cm	30

* rail without 12 V power supply insert

article code	product description	page nr.
SL10120	steelcable with loop 200 cm	30
SL10125	steelcable with loop 250 cm	30
SL10130	steelcable with loop 300 cm	30
HW10200	hook windsor white	30
HW30200	hook windsor alu	30
HW60200	hook windsor gold	30
HW50700	hook riva	30

STAS evoluon & qubic hooks and cords 31

HA30900	smartspring (4 kg perlon)	31
HA30501	zipper (15 kg perlon + 20 kg steel)	31
HA30530	zipper pro (15 kg perlon + 20 kg steel)	31
PH10013	perlon cord with glider 13 cm	31
PH10110	perlon cord with glider 100 cm	31
PH10115	perlon cord with glider 150 cm	31
PH10120	perlon cord with glider 200 cm	31
PH10125	perlon cord with glider 250 cm	31
PH10130	perlon cord with glider 300 cm	31
SH10313	steelcable with glider 13 cm	31
SH10110	steelcable with glider 100 cm	31
SH10115	steelcable with glider 150 cm	31
SH10120	steelcable with glider 200 cm	31
SH10125	steelcable with glider 250 cm	31
SH10130	steelcable with glider 300 cm	31
SH10145	steelcable with glider 450 cm	31
TCS9016	STAS evoluon hook	14

Magnetic hanging solutions 33

BM20360	magnet set	34
MB10050	white magnets (10 pieces)	34
BM20370	coloured magnet set	34
MB10040	coloured magnets (10 pieces)	34
BM20380	magnet set 2-in-1 (cobra + loop)	34

Other hanging solutions 35

STAS qubic 36

TCS1002	qubic hanger	36
TCS9002	qubic end cap black	36
SJ30200	screw qubic	36
SR50700	plug	36

STAS qubic pro 37

TCS1010	qubic pro hanger	37
TCS9002	qubic endcap black	37
SJ30100	screw qubic pro	37
SR50700	plug	37

STAS v-tense & h-tense 38

TSBV150	v-tense 150 cm	38
---------	----------------	----

article code	product description	page nr.
TSBV300	v-tense 300 cm	38
TSBV450	v-tense 450 cm	38
TSBH150	h-tense 150 cm	39
TSBH300	h-tense 300 cm	39
TSBH450	h-tense 450 cm	39

STAS v-tense & h-tense accessories 40

TCS30001	frame clamp (4,5 mm)	40
TCS30002	frame connector (4,5 mm)	40
TCS30003	frame clamp (8,5 mm)	40
TCS30004	frame connector (8,5 mm)	40
TCS30010	tense-frame	40
TCS30005	shelf clamp (8,5 mm)	40
TCS30006	shelf connector (8,5 mm)	40
TCS30025	shelf 20 x 30 cm	40
TCS30007	signage clip	40
MC10100	metal clothespin	40
TCS30015	tense LED fame	40
VT30600	tense 12V power	40
HA30600	security hook	40

STAS papergrip 44

PG10105	papergrip white 50 cm	44
PG10110	papergrip white 100 cm	44
PG10115	papergrip white 150 cm	44
PG10120	papergrip white 200 cm	44
PG15005	papergrip white textured 50 cm	44
PG15010	papergrip white textured 100 cm	44
PG15015	papergrip white textured 150 cm	44
PG15020	papergrip white textured 200 cm	44
PG20105	papergrip black textured 50 cm	44
PG20110	papergrip black textured 100 cm	44
PG20115	papergrip black textured 150 cm	44
PG20120	papergrip black textured 200 cm	44
PG30105	papergrip alu textured 50 cm	44
PG30110	papergrip alu textured 100 cm	44
PG30115	papergrip alu textured 150 cm	44
PG10120	papergrip alu textured 200 cm	44
PG90001	papergrip end cap white	44
PG90002	papergrip end cap black	44
PG90003	papergrip end cap alu	44
HA40410	papergrip hook white	44
HA40412	papergrip hook alu	44
HA40411	papergrip hook black	44
RD40100	railclip (metal, 3 per m ²)	44
RD40200	rail connector (metal)	44
SR30100	screw	44
SR30600	screw torx	44
SR50700	plug 6 x 30 mm hard / soft wall	44

article code	product description	page nr.
STAS papergrip hanger		45
HA40110	papergrip hanger	45
PG40110	papergrip hanger stabilisation set	45

STAS name tag 46

PG20007	name tag	46
---------	----------	----

STAS wall-strip 47

WS40400	wall-strip	47
---------	------------	----

STAS paperrail 48

KN10005	paperrail white 50 cm	48
KN30005	paperrail alu 50 cm	48
KN10010	paperrail white 100 cm	48
KN30010	paperrail alu 100 cm	48
KN10020	paperrail white 200 cm	48
KN30020	paperrail alu 200 cm	48
KN30100	paperrail connector set	48
SR10000	clipscrew	48
SR50700	plug 6 x 30 mm hard / soft wall	48

STAS panel hooks 49

HW10300	panel hook white 11 mm	49
HW10400	panel hook white 16 mm	49
HW10600	panel hook white 18 mm	49
HW10500	panel hook white 21 mm	49
HW10700	panel hook white 26 mm	49
HW10800	panel hook white 31 mm	49
HW30700	panel hook alu interselect	49
HW30800	panel hook alu lux window frame	49
HW50100	panel hook transparant alcoa	49
HW30300	panel hook alu verwol type 1*	49
HW30400	panel hook alu verwol type 2	49
HW30500	panel hook alu sepa normal	49
HW10200	molding hook white	49
HW30200	molding hook alu	49
HW60200	molding hook gold	49
HW50400	panel hook askon chrome	49
HW50500	panel hook PE transparant	49
HW50600	panel hook maars	49

STAS picture hits 50

BM20350	picture hits	50
---------	--------------	----

STAS set up 51

RR10120	set up white 145 cm	51
RR30120	set up alu 145 cm	51
KN30100	set up connector set	51
SJ10100	screw flush head white	51

article code	product description	page nr.
SJ30100	screw flush head alu	51
SR50700	plug 6 x 30 mm hard / soft wall	51

STAS poster strips en snaps

PS30050	poster snap set alu 50 cm	52
PS30070	poster snap set alu 70 cm	52
PS30100	poster snap set alu 100 cm	52
PS50030	poster strip set transparant 30 cm	52
PS50042	poster strip set transparant 42 cm	52
PS50050	poster strip set transparant 50 cm	52
PS50060	poster strip set transparant 60 cm	52
PS50070	poster strip set transparant 70 cm	52

article code	product description	page nr.
PS50084	poster strip set transparant 84 cm	52
PS50110	poster strip set transparant 100 cm	52

STAS suspended ceiling hooks

HA10100	suspended ceiling hook white	53
HA10200	suspended ceiling hook for loop	53

STAS dibond hangers

BS30300	dibond hanger set 3 kg	53
BS30600	dibond hanger set 6 kg	53
MB10080	selfadhesive distance caps round 13 mm (4 st)	53

article code	product description	page nr.
--------------	---------------------	----------

Aanvullende producten

STAS clocktica

KH40430W	clocktica wit 43 cm	54
KH40950W	clocktica wit 95 cm	54
KH40430R	clocktica RVS 43 cm	54
KH40950R	clocktica RVS 95 cm	54
KH40430Z	clocktica zwart 43 cm	54
KH40950Z	clocktica zwart 95 cm	54

STAS tunica

KH40095W	tunica wit 95 cm	55
KH40095Z	tunica zwart 95 cm	55



STAS products TÜV certified

STAS strives day after day for products of the highest quality. To guarantee the quality and independence of products, STAS has commissioned TÜV Netherlands for the testing of its products. TÜV Netherlands is an independent and recognized body that assesses the quality of products according to a set standard and has extensive experience in the field of product safety and product inspections. Under the direction of TÜV, a large part of our range of products has been tested for quality and correctness of the specified features. All products where the TÜV logo is shown, have actually been tested by TÜV Netherlands and approved for the capacity that is stated in the features of that product.



STAS picture hanging systems

28 Town Forest Rd | Unit B | Webster | MA 01570 | USA

T 888-827-8349 | info@stasgroup.com

www.picturehangingsystems.com

Important note regarding warranty and liability

Products of STAS must be installed and used only in strict accordance with the latest version of the STAS picture hanging systems installation guide, available for download at www.stasgroup.com. It is the responsibility of the installer to select the correct fasteners for the particular installation. Improper installation, misuse, misapplication or otherwise failing to completely follow seller's instructions and warnings may cause product malfunction, property damage or personal injury.